

TD2 automatisme industriel (révision porte logique)

☐ Etablir les équations des schémas suivants.

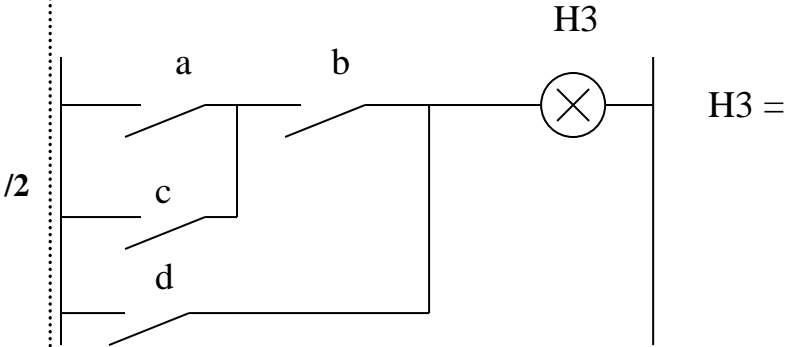

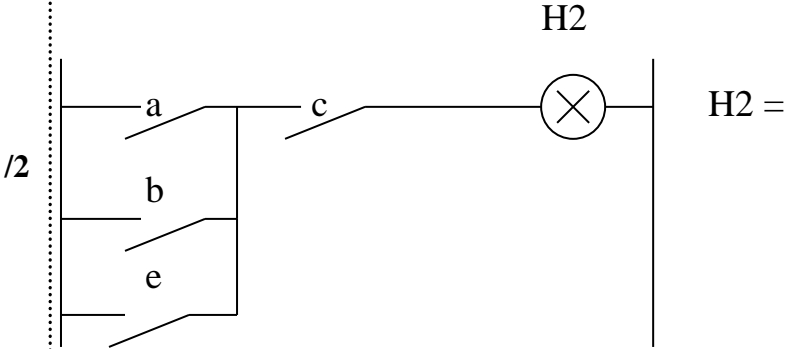

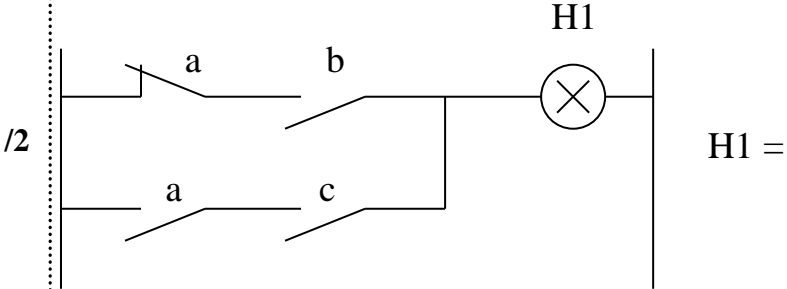
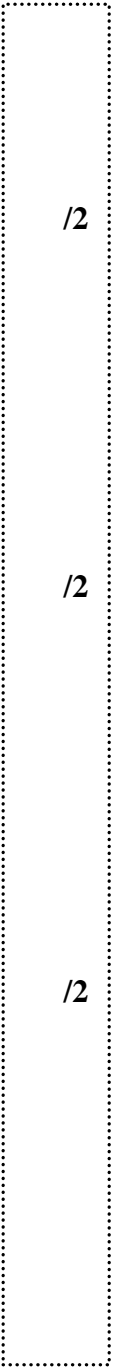
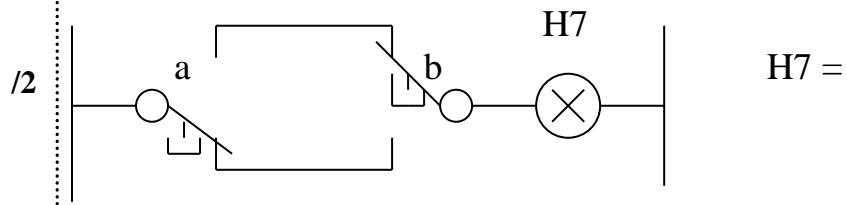
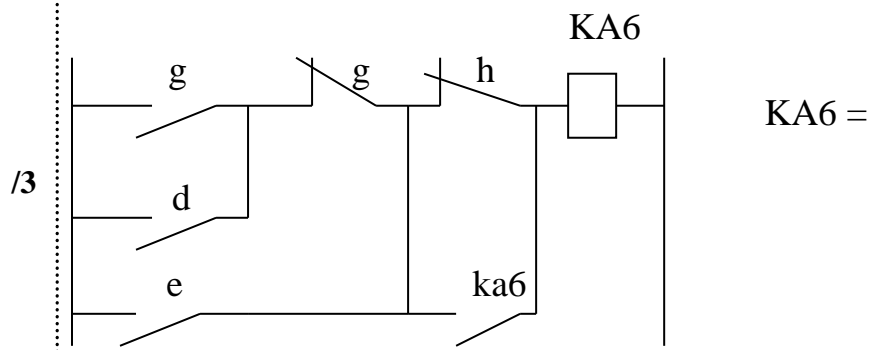
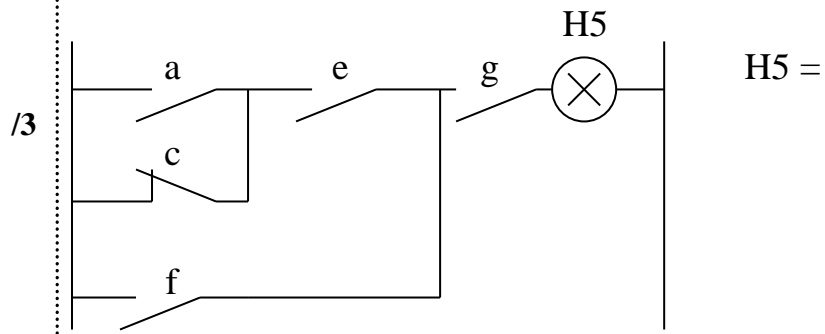
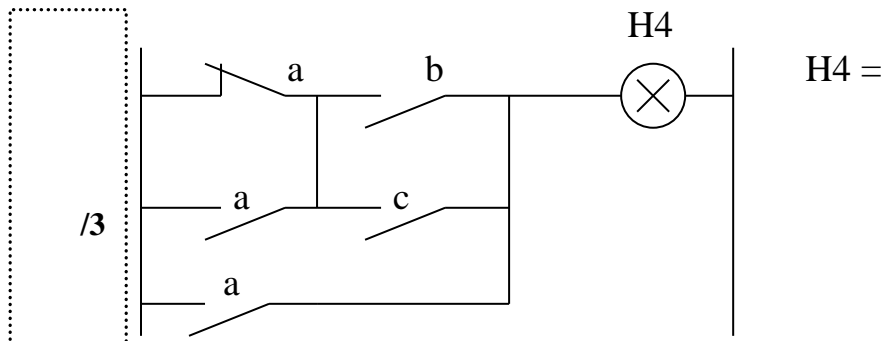
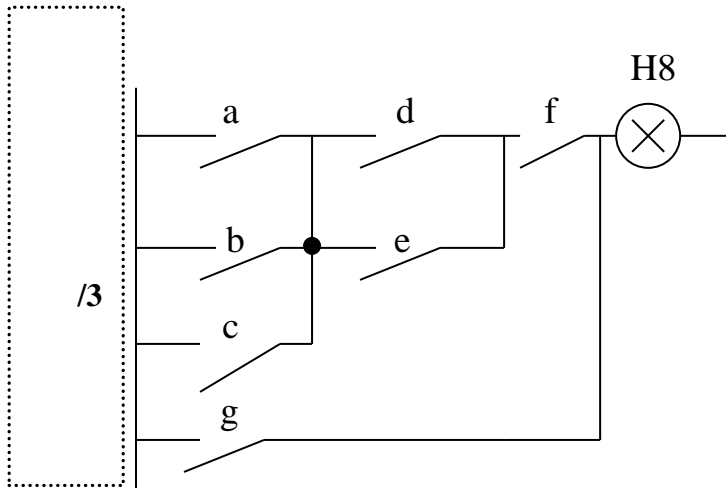

H8 =