

Chapter 2. Review of Symmetrical Components and Fault Currents

1 Introduction

Installment 3 of these notes dealt *primarily* with networks that are *balanced*, in which the three voltages (and three currents) are identical but for exact 120° phase shifts. Unbalanced conditions may arise from unequal voltage sources or loads. It *is* possible to analyze some simple types of unbalanced networks using straightforward solution techniques and *wye-delta* transformations. However, power networks can be come quite complex and many situations would be very difficult to handle using ordinary network analysis. For this reason, a technique which has come to be called *symmetrical components* has been developed.

Symmetrical components, in addition to being a powerful analytical tool, is also conceptually useful. The symmetrical components themselves, which are obtained from a transformation of the ordinary line voltages and currents, are useful in their own right. Symmetrical components have become accepted as one way of describing the properties of many types of network elements such as transmission lines, motors and generators.

2 The Symmetrical Component Transformation

The basis for this analytical technique is a transformation of the three voltages and three currents into a second set of voltages and currents. This second set is known as the *symmetrical components*.

Working in complex amplitudes:

$$v_a = \operatorname{Re} \left(\underline{V}_a e^{j\omega t} \right) \quad (1)$$

$$v_b = \operatorname{Re} \left(\underline{V}_b e^{j(\omega t - \frac{2\pi}{3})} \right) \quad (2)$$

$$v_c = \operatorname{Re} \left(\underline{V}_c e^{j(\omega t + \frac{2\pi}{3})} \right) \quad (3)$$

The transformation is defined as:

$$\begin{bmatrix} \underline{V}_1 \\ \underline{V}_2 \\ \underline{V}_0 \end{bmatrix} = \frac{1}{3} \begin{bmatrix} 1 & \underline{a} & \underline{a}^2 \\ 1 & \underline{a}^2 & \underline{a} \\ 1 & 1 & 1 \end{bmatrix} \begin{bmatrix} \underline{V}_a \\ \underline{V}_b \\ \underline{V}_c \end{bmatrix} \quad (4)$$

where the complex number \underline{a} is:

$$\underline{a} = e^{j\frac{2\pi}{3}} = -\frac{1}{2} + j\frac{\sqrt{3}}{2} \quad (5)$$

$$\underline{a}^2 = e^{j\frac{4\pi}{3}} = e^{-j\frac{2\pi}{3}} = -\frac{1}{2} - j\frac{\sqrt{3}}{2} \quad (6)$$

$$\underline{a}^3 = 1 \quad (7)$$

This transformation may be used for both voltage and current, and works for variables in *ordinary* form as well as variables that have been normalized and are in *per-unit* form. The inverse of this transformation is:

$$\begin{bmatrix} \underline{V}_a \\ \underline{V}_b \\ \underline{V}_c \end{bmatrix} = \begin{bmatrix} 1 & 1 & 1 \\ \underline{a}^2 & \underline{a} & 1 \\ \underline{a} & \underline{a}^2 & 1 \end{bmatrix} \begin{bmatrix} \underline{V}_1 \\ \underline{V}_2 \\ \underline{V}_0 \end{bmatrix} \quad (8)$$

The three component variables \underline{V}_1 , \underline{V}_2 , \underline{V}_0 are called, respectively, *positive sequence*, *negative sequence* and *zero sequence*. They are called *symmetrical components* because, taken *separately*, they transform into symmetrical sets of voltages. The properties of these components can be demonstrated by transforming each one back into phase variables.

Consider first the *positive sequence* component taken by itself:

$$\underline{V}_1 = V \quad (9)$$

$$\underline{V}_2 = 0 \quad (10)$$

$$\underline{V}_0 = 0 \quad (11)$$

yields:

$$\underline{V}_a = V \quad \text{or} \quad v_a = V \cos \omega t \quad (12)$$

$$\underline{V}_b = \underline{a}^2 V \quad \text{or} \quad v_b = V \cos(\omega t - \frac{2\pi}{3}) \quad (13)$$

$$\underline{V}_c = \underline{a} V \quad \text{or} \quad v_c = V \cos(\omega t + \frac{2\pi}{3}) \quad (14)$$

This is the familiar *balanced* set of voltages: Phase b lags phase a by 120°, phase c lags phase b and phase a lags phase c.

The same transformation carried out on a *negative sequence* voltage:

$$\underline{V}_1 = 0 \quad (15)$$

$$\underline{V}_2 = V \quad (16)$$

$$\underline{V}_0 = 0 \quad (17)$$

yields:

$$\underline{V}_a = V \quad \text{or} \quad v_a = V \cos \omega t \quad (18)$$

$$\underline{V}_b = \underline{a}V \quad \text{or} \quad v_b = V \cos(\omega t + \frac{2\pi}{3}) \quad (19)$$

$$\underline{V}_c = \underline{a}^2V \quad \text{or} \quad v_c = V \cos(\omega t - \frac{2\pi}{3}) \quad (20)$$

This is called *negative sequence* because the sequence of voltages is reversed: phase b now *leads* phase a rather than lagging. Note that the negative sequence set is still balanced in the sense that the phase components still have the same magnitude and are separated by 120° . The only difference between positive and negative sequence is the phase rotation. This is shown in Figure 1.

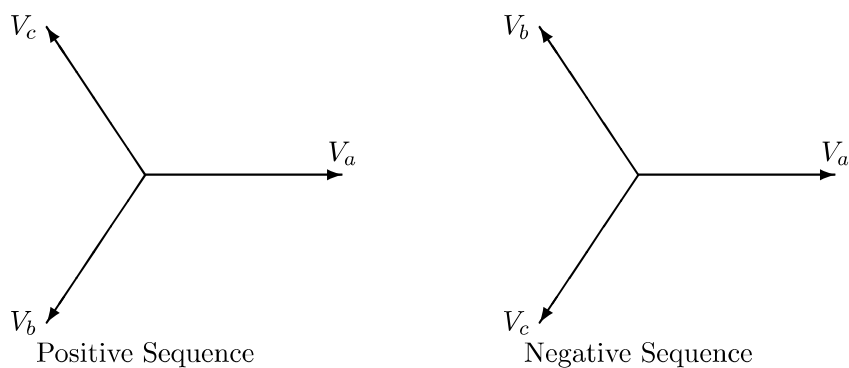

Figure 1: Phasor Diagram: Three Phase Voltages

The third symmetrical component is *zero sequence*. If:

$$\underline{V}_1 = 0 \quad (21)$$

$$\underline{V}_2 = 0 \quad (22)$$

$$\underline{V}_0 = V \quad (23)$$

Then:

$$\underline{V}_a = V \quad \text{or} \quad v_a = V \cos \omega t \quad (24)$$

$$\underline{V}_b = V \quad \text{or} \quad v_b = V \cos \omega t \quad (25)$$

$$\underline{V}_c = V \quad \text{or} \quad v_c = V \cos \omega t \quad (26)$$

That is, all three phases are varying *together*.

Positive and negative sequence sets contain those parts of the three-phase excitation that represent balanced normal and reverse phase sequence. Zero sequence is required to make up the difference between the total phase variables and the two *rotating* components.

The great utility of symmetrical components is that, for most types of network elements, the symmetrical components are independent of each other. In particular, balanced impedances and rotating machines will draw only positive sequence currents in response to positive sequence voltages. It is thus possible to describe a network in terms of sub-networks, one for each of the symmetrical

components. These are called *sequence networks*. A completely balanced network will have three entirely separate sequence networks. If a network is unbalanced at a particular spot, the sequence networks will be interconnected at that spot. The key to use of symmetrical components in handling unbalanced situations is in learning how to formulate those interconnections.

3 Sequence Impedances

Many different types of network elements exhibit different behavior to the different symmetrical components. For example, as we will see shortly, transmission lines have one impedance for positive and negative sequence, but an entirely different impedance to zero sequence. Rotating machines have different impedances to all three

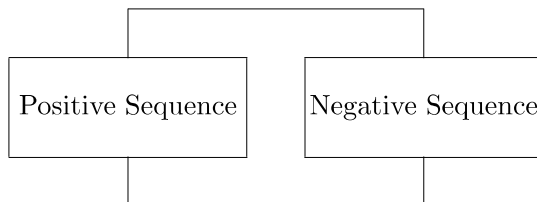

Figure 2: Sequence Connections For A Line-To-Line Fault

sequences.

To illustrate the independence of symmetrical components in balanced networks, consider the transmission line illustrated back in Figure 20 of Installment 3 of these notes. The expressions for voltage drop in the lines may be written as a single vector expression:

$$\underline{V}_{ph1} - \underline{V}_{ph2} = j\omega \underline{L}_{ph} \underline{I}_{ph} \quad (27)$$

where

$$\underline{V}_{ph} = \begin{bmatrix} \underline{V}_a \\ \underline{V}_b \\ \underline{V}_c \end{bmatrix} \quad (28)$$

$$\underline{I}_{ph} = \begin{bmatrix} \underline{I}_a \\ \underline{I}_b \\ \underline{I}_c \end{bmatrix} \quad (29)$$

$$\underline{L}_{ph} = \begin{bmatrix} L & M & M \\ M & L & M \\ M & M & L \end{bmatrix} \quad (30)$$

Note that the symmetrical component transformation (4) may be written in compact form:

$$\underline{V}_s = \underline{T} \underline{V}_p \quad (31)$$

where

$$\underline{\underline{T}} = \frac{1}{3} \begin{bmatrix} 1 & \underline{a} & \underline{a}^2 \\ 1 & \underline{a}^2 & \underline{a} \\ 1 & 1 & 1 \end{bmatrix} \quad (32)$$

and \underline{V}_s is the vector of sequence voltages:

$$\underline{V}_s = \begin{bmatrix} \underline{V}_1 \\ \underline{V}_2 \\ \underline{V}_0 \end{bmatrix} \quad (33)$$

Rewriting (27) using the inverse of (31):

$$\underline{\underline{T}}^{-1}\underline{V}_{s1} - \underline{\underline{T}}^{-1}\underline{V}_{s2} = j\omega\underline{\underline{L}}_{ph}\underline{\underline{T}}^{-1}\underline{I}_s \quad (34)$$

Then transforming to get sequence voltages:

$$\underline{V}_{s1} - \underline{V}_{s2} = j\omega\underline{\underline{T}}\underline{\underline{L}}_{ph}\underline{\underline{T}}^{-1}\underline{I}_s \quad (35)$$

The sequence inductance matrix is defined by carrying out the operation indicated:

$$\underline{\underline{L}}_s = \underline{\underline{T}}\underline{\underline{L}}_{ph}\underline{\underline{T}}^{-1} \quad (36)$$

which is:

$$\underline{\underline{L}}_s = \begin{bmatrix} L - M & 0 & 0 \\ 0 & L - M & 0 \\ 0 & 0 & L + 2M \end{bmatrix} \quad (37)$$

Thus the *coupled* set of expressions which described the transmission line in *phase* variables becomes an *uncoupled* set of expressions in the symmetrical components:

$$\underline{V}_{11} - \underline{V}_{12} = j\omega(L - M)\underline{I}_1 \quad (38)$$

$$\underline{V}_{21} - \underline{V}_{22} = j\omega(L - M)\underline{I}_2 \quad (39)$$

$$\underline{V}_{01} - \underline{V}_{02} = j\omega(L + 2M)\underline{I}_0 \quad (40)$$

The *positive*, *negative* and *zero* sequence impedances of the balanced transmission line are then:

$$\underline{Z}_1 = \underline{Z}_2 = j\omega(L - M) \quad (41)$$

$$\underline{Z}_0 = j\omega(L + 2M) \quad (42)$$

So, in analysis of networks with transmission lines, it is now possible to replace the lines with three *independent*, single- phase networks.

Consider next a balanced three-phase load with its neutral connected to ground through an impedance as shown in Figure 3.

The symmetrical component voltage-current relationship for this network is found simply, by assuming positive, negative and zero sequence currents and finding the corresponding voltages. If this is done, it is found that the symmetrical components *are* independent, and that the voltage-current relationships are:

$$\underline{V}_1 = \underline{Z}\underline{I}_1 \quad (43)$$

$$\underline{V}_2 = \underline{Z}\underline{I}_2 \quad (44)$$

$$\underline{V}_0 = (\underline{Z} + 3\underline{Z}_g)\underline{I}_0 \quad (45)$$

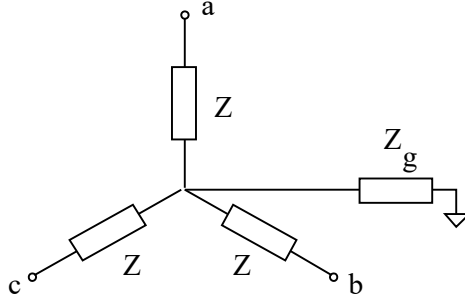

Figure 3: Balanced Load With Neutral Impedance

4 Unbalanced Sources

Consider the network shown in Figure 4. A balanced three-phase resistor is fed by a balanced line (with mutual coupling between phases). Assume that only one phase of the voltage source is working, so that:

$$\underline{V}_a = V \quad (46)$$

$$\underline{V}_b = 0 \quad (47)$$

$$\underline{V}_c = 0 \quad (48)$$

The objective of this example is to find currents in the three phases.

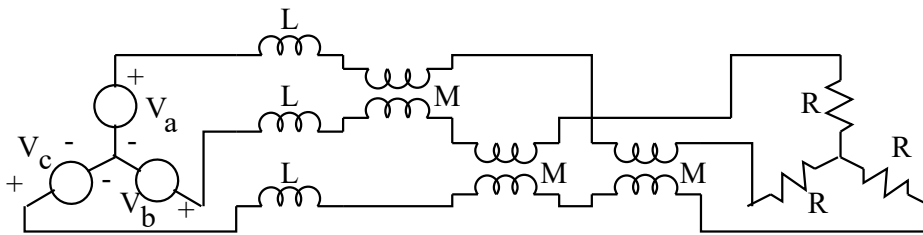

Figure 4: Balanced Load, Balanced Line, Unbalanced Source

To start, note that the unbalanced voltage source has the following set of symmetrical components:

$$\underline{V}_1 = \frac{V}{3} \quad (49)$$

$$\underline{V}_2 = \frac{V}{3} \quad (50)$$

$$\underline{V}_0 = \frac{V}{3} \quad (51)$$

Next, the network facing the source consists of the line, with impedances:

$$\underline{Z}_1 = j\omega(L - M) \quad (52)$$

$$\underline{Z}_2 = j\omega(L - M) \quad (53)$$

$$\underline{Z}_0 = j\omega(L + 2M) \quad (54)$$

and the three- phase resistor has impedances:

$$\underline{Z}_1 = R \quad (55)$$

$$\underline{Z}_2 = R \quad (56)$$

$$\underline{Z}_0 = \infty \quad (57)$$

Note that the impedance to zero sequence is infinite because the neutral is not connected back to the neutral of the voltage source. Thus the sum of line currents must always be zero and this in turn precludes any zero sequence current. The problem is thus described by the networks which appear in Figure 5.

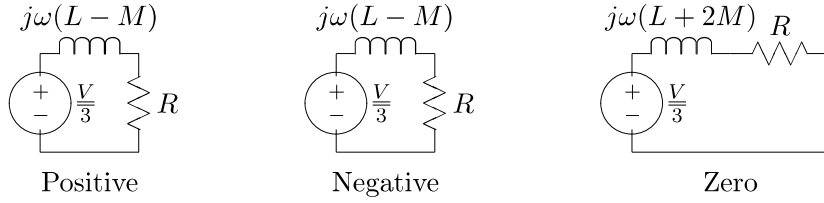

Figure 5: Sequence Networks

Currents are:

$$\underline{I}_1 = \frac{V}{3(j\omega(L - M) + R)}$$

$$\underline{I}_2 = \frac{V}{3(j\omega(L - M) + R)}$$

$$\underline{I}_0 = 0$$

Phase currents may now be re-assembled:

$$\underline{I}_a = \underline{I}_1 + \underline{I}_2 + \underline{I}_0$$

$$\underline{I}_b = \underline{a}^2 \underline{I}_1 + \underline{a} \underline{I}_2 + \underline{I}_0$$

$$\underline{I}_c = \underline{a} \underline{I}_1 + \underline{a}^2 \underline{I}_2 + \underline{I}_0$$

or:

$$\underline{I}_a = \frac{2V}{3(j\omega(L - M) + R)}$$

$$\underline{I}_b = \frac{(\underline{a}^2 + \underline{a})V}{3(j\omega(L - M) + R)}$$

$$\begin{aligned}
&= \frac{-V}{3(j\omega(L - M) + R)} \\
\underline{I}_c &= \frac{(\underline{a} + \underline{a}^2)V}{3(j\omega(L - M) + R)} \\
&= \frac{-V}{3(j\omega(L - M) + R)}
\end{aligned}$$

(Note that we have used $\underline{a}^2 + \underline{a} = -1$).

5 Rotating Machines

Some network elements are more readily represented by sequence networks than by ordinary phase networks. This is the case, for example, for synchronous machines. Synchronous motors and generators produce a positive sequence *internal* voltage and have terminal impedance. For reasons which are beyond the scope of these notes, the impedance to positive sequence currents is not the same as the impedance to negative or to zero sequence currents. A phase-by-phase representation will not, in many situations, be adequate, but a sequence network representation will. Such a representation is three Thevenin equivalent circuits, as shown in Figure 6

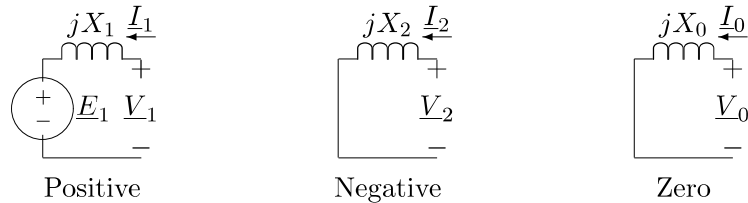

Figure 6: Sequence Networks For A Synchronous Machine

6 Transformers

Transformers provide some interesting features in setting up sequence networks. The first of these arises from the fact that wye-delta or delta-wye transformer connections produce phase shifts from primary to secondary. Depending on connection, this phase shift may be either plus or minus 30° from primary to secondary for positive sequence voltages and currents. It is straightforward to show that *negative* sequence shifts in the *opposite* direction from *positive*. Thus if the connection *advances* positive sequence across the transformer, it *retards* negative sequence. This does not turn out to affect the setting up of sequence networks, but does affect the re-construction of phase currents and voltages.

A second important feature of transformers arises because delta and ungrounded wye connections are open circuits to zero sequence at their terminals. A delta connected winding, on the other hand, will provide a short circuit to zero sequence currents induced from a wye connected winding. Thus the zero sequence network of a transformer may take one of several forms. Figures 7 through 9 show the zero sequence networks for various transformer connections.

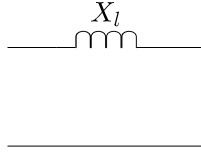

Figure 7: Zero Sequence Network: Wye-Wye Connection, Both Sides Grounded

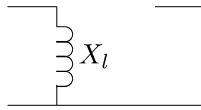

Figure 8: Zero Sequence Network: Wye-Delta Connection, Wye Side (Left) Grounded

7 Unbalanced Faults

A very common application of symmetrical components is in calculating currents arising from unbalanced short circuits. For three-phase systems, the possible unbalanced faults are:

1. Single line-ground,
2. Double line-ground,
3. Line-line.

These are considered separately.

7.1 Single Line-To-Ground Fault

The situation is as shown in Figure 10

The *system* in this case consists of networks connected to the line on which the fault occurs. The point of fault itself consists of a set of terminals (which we might call “a,b,c”). The fault sets,



Figure 9: Zero Sequence Network: Wye-Delta Connection, Ungrounded or Delta-Delta

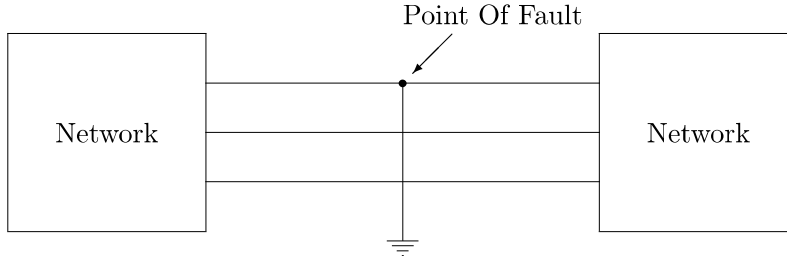

Figure 10: Schematic Picture Of A Single Line-To-Ground Fault

at this point on the system:

$$\begin{aligned}\underline{V}_a &= 0 \\ \underline{I}_b &= 0 \\ \underline{I}_c &= 0\end{aligned}$$

Now: using the inverse of the symmetrical component transformation, we see that:

$$\underline{V}_1 + \underline{V}_2 + \underline{V}_0 = 0 \quad (58)$$

And using the transformation itself:

$$\underline{I}_1 = \underline{I}_2 = \underline{I}_0 = \frac{1}{3}\underline{I}_a \quad (59)$$

Together, these two expressions describe the *sequence network* connection shown in Figure 11. This connection has all three sequence networks connected in *series*.

7.2 Double Line-To-Ground Fault

If the fault involves phases b, c, and ground, the “terminal” relationship at the point of the fault is:

$$\begin{aligned}\underline{V}_b &= 0 \\ \underline{V}_c &= 0 \\ \underline{I}_a &= 0\end{aligned}$$

Then, using the sequence transformation:

$$\underline{V}_1 = \underline{V}_2 = \underline{V}_0 = \frac{1}{3}\underline{V}_a$$

Combining the inverse transformation:

$$\underline{I}_a = \underline{I}_1 + \underline{I}_2 + \underline{I}_0 = 0$$

These describe a situation in which all three sequence networks are connected in parallel, as shown in Figure 12.

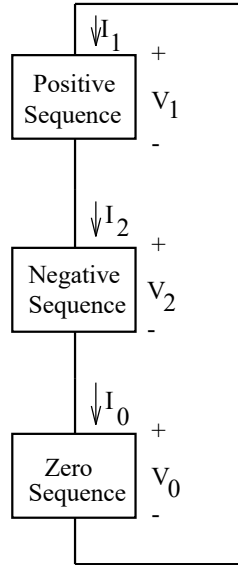

Figure 11: Sequence Connection For A Single-Line-To-Ground Fault

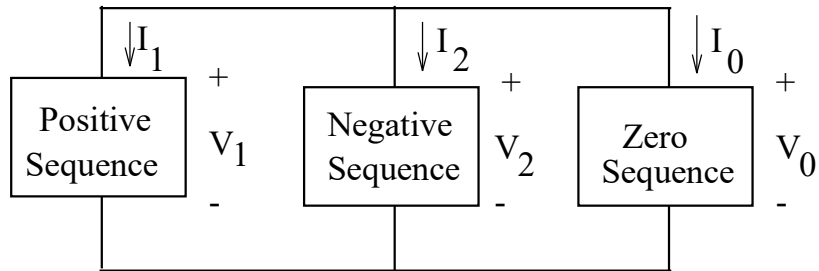

Figure 12: Sequence Connection For A Double-Line-To-Ground Fault

7.3 Line-Line Fault

If phases b and c are shorted together but not grounded,

$$\begin{aligned} V_b &= V_c \\ I_b &= -I_c \\ I_a &= 0 \end{aligned}$$

Expressing these in terms of the symmetrical components:

$$\begin{aligned} V_1 &= V_2 \\ &= \frac{1}{3}(a + a^2)V_b \\ I_0 &= I_a + I_b + I_c \\ &= 0 \\ I_a &= I_1 + I_2 \end{aligned}$$

$$= 0$$

These expressions describe a parallel connection of the positive and negative sequence networks, as shown in Figure 13.

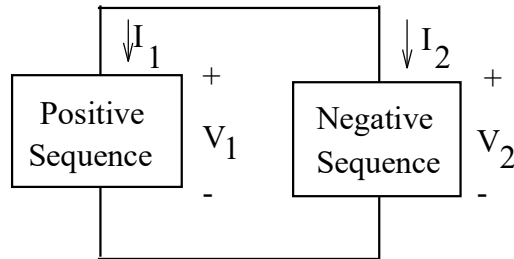

Figure 13: Sequence Connection For A Line-To-Line Fault

7.4 Example Of Fault Calculations

In this example, the objective is to determine maximum current through the breaker **B** due to a fault at the location shown in Figure 14. All three types of unbalanced fault, as well as the balanced fault are to be considered. This is the sort of calculation that has to be done whenever a line is installed or modified, so that protective relaying can be set properly.

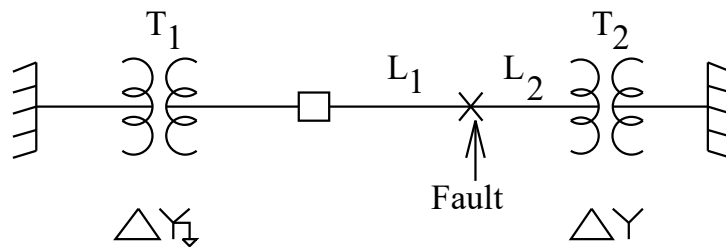

Figure 14: One-Line Diagram For Example Fault

Parameters of the system are:

System Base Voltage	138 kV
System Base Power	100 MVA
Transformer T_1 Leakage Reactance	.1 per-unit
Transformer T_2 Leakage Reactance	.1 per-unit
Line L_1 Positive And Negative Sequence Reactance	j.05 per-unit
Line L_1 Zero Sequence Impedance	j.1 per-unit
Line L_2 Positive And Negative Sequence Reactance	j.02 per-unit
Line L_2 Zero Sequence Impedance	j.1 per-unit

The fence-like symbols at either end of the figure represent “infinite buses”, or positive sequence voltage sources.

The first step in this is to find the sequence networks. These are shown in Figure 15. Note that they are exactly like what we would expect to have drawn for equivalent single phase networks. Only the positive sequence network has sources, because the infinite bus supplies only positive sequence voltage. The zero sequence network is open at the right hand side because of the *delta-ye* transformer connection there.

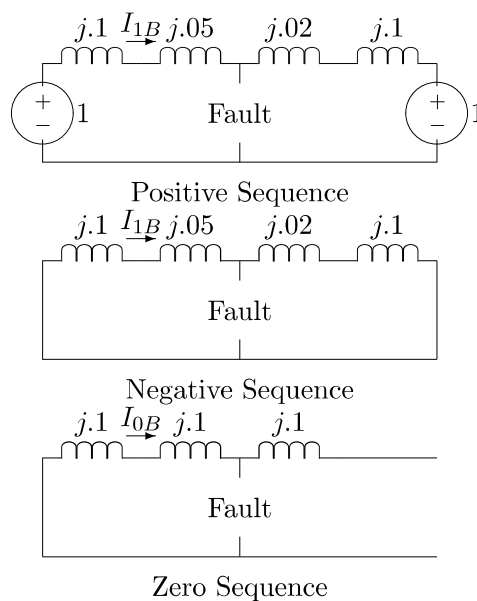

Figure 15: Sequence Networks

7.4.1 Symmetrical Fault

For a symmetrical (three-phase) fault, only the positive sequence network is involved. The fault shorts the network at its position, so that the current is:

$$\underline{i}_1 = \frac{1}{j.15} = -j6.67 \text{ per - unit}$$

7.4.2 Single Line-Ground Fault

For this situation, the three networks are in series and the situation is as shown in Figure 16

The current \underline{i} shown in Figure 16 is a *total* current, and is given by:

$$\underline{i} = \frac{1}{2 \times (j.15 || j.12) + j.2} = -j3.0$$

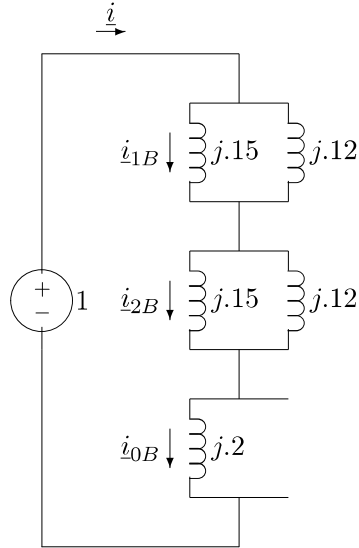

Figure 16: Completed Network For Single Line-Ground Fault

Then the *sequence currents* at the breaker are:

$$\begin{aligned}
 \underline{i}_{1B} &= \underline{i}_{2B} \\
 &= \underline{i} \times \frac{j.12}{j.12 + j.15} \\
 &= -j1.33 \\
 \underline{i}_{0B} &= \underline{i} \\
 &= -j3.0
 \end{aligned}$$

The phase currents are re-constructed using:

$$\begin{aligned}
 \underline{i}_a &= \underline{i}_{1B} + \underline{i}_{2B} + \underline{i}_{0B} \\
 \underline{i}_b &= \underline{a}^2 \underline{i}_{1B} + \underline{a} \underline{i}_{2B} + \underline{i}_{0B} \\
 \underline{i}_c &= \underline{a} \underline{i}_{1B} + \underline{a}^2 \underline{i}_{2B} + \underline{i}_{0B}
 \end{aligned}$$

These are:

$$\begin{aligned}
 \underline{i}_a &= -j5.66 \text{ per-unit} \\
 \underline{i}_b &= -j1.67 \text{ per-unit} \\
 \underline{i}_c &= -j1.67 \text{ per-unit}
 \end{aligned}$$

7.4.3 Double Line-Ground Fault

For the double line-ground fault, the networks are in parallel, as shown in Figure 17.

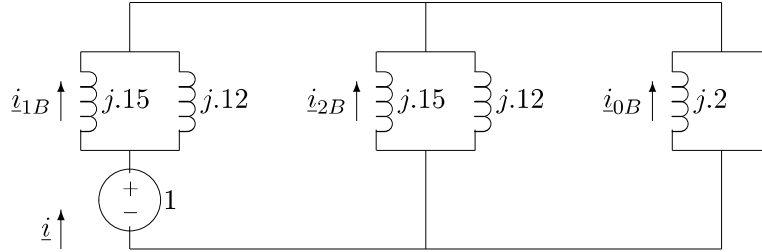

Figure 17: Completed Network For Double Line-Ground Fault

To start, find the source current \underline{i} :

$$\begin{aligned}\underline{i} &= \frac{1}{j(.15||.12) + j(.15||.12||.2)} \\ &= -j8.57\end{aligned}$$

Then the *sequence* currents at the breaker are:

$$\begin{aligned}\underline{i}_{1B} &= \underline{i} \times \frac{j.12}{j.12 + j.15} \\ &= -j3.81 \\ \underline{i}_{2B} &= -\underline{i} \times \frac{j.12||j.2}{j.12||j.2 + j.15} \\ &= j2.86 \\ \underline{i}_{0B} &= \underline{i} \times \frac{j.12||j.15}{j.2 + j.12||j.15} \\ &= j2.14\end{aligned}$$

Reconstructed phase currents are:

$$\begin{aligned}\underline{i}_a &= j1.19 \\ \underline{i}_b &= \underline{i}_{0B} - \frac{1}{2}(\underline{i}_{1B} + \underline{i}_{2B}) - \frac{\sqrt{3}}{2}j(\underline{i}_{1B} - \underline{i}_{2B}) \\ &= j2.67 - 5.87 \\ \underline{i}_c &= \underline{i}_{0B} - \frac{1}{2}(\underline{i}_{1B} + \underline{i}_{2B}) + \frac{\sqrt{3}}{2}j(\underline{i}_{1B} - \underline{i}_{2B}) \\ &= j2.67 + 5.87 \\ |\underline{i}_a| &= 1.19 \text{ per-unit} \\ |\underline{i}_b| &= 6.43 \text{ per-unit} \\ |\underline{i}_c| &= 6.43 \text{ per-unit}\end{aligned}$$

7.4.4 Line-Line Fault

The situation is even easier here, as shown in Figure 18

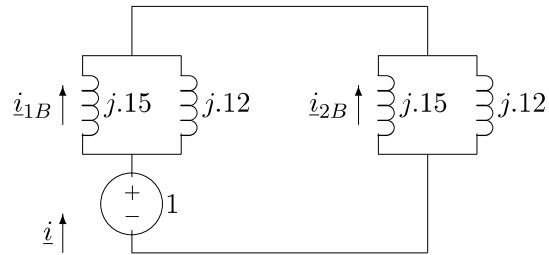

Figure 18: Completed Network For Line-Line Fault

The source current \underline{i} is:

$$\begin{aligned}\underline{i} &= \frac{1}{2 \times j(.15||.12)} \\ &= -j7.50\end{aligned}$$

and then:

$$\begin{aligned}\underline{i}_{1B} &= -\underline{i}_{2B} \\ &= i \frac{j.12}{j.12 + j.15} \\ &= -j3.33\end{aligned}$$

Phase currents are:

$$\begin{aligned}\underline{i}_a &= 0 \\ \underline{i}_b &= -\frac{1}{2}(\underline{i}_{1B} + \underline{i}_{2B}) - j\frac{\sqrt{3}}{2}(\underline{i}_{1B} - \underline{i}_{2B}) \\ |\underline{i}_b| &= 5.77 \text{ per-unit} \\ |\underline{i}_c| &= 5.77 \text{ per-unit}\end{aligned}$$

7.4.5 Conversion To Amperes

Base current is:

$$I_B = \frac{P_B}{\sqrt{3}V_{Bl-l}} = 418.4A$$

Then current amplitudes are, in Amperes, RMS:

	Phase A	Phase B	Phase C
Three-Phase Fault	2791	2791	2791
Single Line-Ground, ϕ_a	2368	699	699
Double Line-Ground, ϕ_b, ϕ_c	498	2690	2690
Line-Line, ϕ_b, ϕ_c	0	2414	2414